



re-light

LED TRI-PROOF LIGHT

O Series Specification sheet



OPTION



Emergency



Dimmable



DALI



Sensor



IP66 IK08



PRODUCT DESCRIPTION

Our Tri-proof light is usually used in environment which require water-proof ,dust-proof ,corrosion-proof lighting ,such as shopping mall , warehouse and other indoor places . The lamp features with smooth surface , no dust deposition ,can be ceiling mounted or suspending mounted.

FEATURES:

- Water-proof design without adhesive, so there is no water leakage caused by adhesive aging , Convenient to disassemble;
- Light panel and PSU adopt modular design, connected via terminals, easy and convenient to Maintain, no need of soldering;
- Energy saving and eco-friendly, no IR or UV, no mercury contamination , RoHS compliant;
- High transmittance PC cover transmit soft light + small power LEDs, high light efficiency, uniform Light; No dark spot;
- High efficient heat dissipation, LEDs and power supply with low temperature rise, high stability under Continuous working;
- Can be switched on/off frequently, good color rendering performance. Compact appearance, novel design style, easy to install and transport;

APPLICATIONS:

Car Washes/Food processing
 Gas Station/Laboratories
 Industrial Facilities
 Refrigeration/Freezers
 Parking Garage/Utility
 Warehouse/Supermarket
 Chicken farm / Cattle farm



Dimensions (mm)



Size	L	W	H
60cm(2 feet)	590mm	95mm	75mm
120cm(4 feet)	1190mm	95mm	75mm
150cm(5 feet)	1490mm	95mm	75mm



re-light



IK08 **IP66**
IMPACT PROTECTION OUTDOOR RATED



Standard



IP66 IK08

Technical specifications(Ta=25 °C) GWT 650 °C / 850 °C

Model	SL-SFA00-220LT-H-O	SL-SFA00-440LT-H-O	SL-SFA00-560LT-H-O
Length	60 cm (2 feet)	120cm (4 feet)	150cm (5 feet)
Power(adjustable)	12/14/17/20 W	25/30/35/40 W	35/40/50/60 W
Weight	0.77 KG	1.26 KG	1.55 KG
Cover	Diffusion/frost		
Material	ABS + PC / PC + PC / GRP + PC		
Energy Efficiency Class	A+		
Electrical Protection	Class I		
Color	3000K / 4000K / 5000K / 6000K		
CRI	>80		
Luminous efficacy (lm/w)	120-130	120-130	120-130
Driver	FULTON		
Input Voltage	200~240V AC 50/60Hz		
Power Factor	≥0.92		
THD	≤20%		
Beam angle	120°		
Average Lifespan Ta25 °C	>50,000 hours		
Warranty	3 years		
Operating Temperature	-20°C~+45°C		
IP Rating	IP66		
Standard	CE、RoHS、D-MARK、SAA、IK08		

- *Note: 1) 3000K comes up with lower lumen.
 2) Luminous Flux tolerance ±5%.
 3) The above data are tested by SL instruments.

*Please contact our sales representative to order products that don't have order codes listed here or any info required
 *Due to continuing product improvements, SL reserves the right to change the specifications without notice.



re-light



IK08 **IP66**
IMPACT PROTECTION OUTDOOR RATED



POWER/CCT Adjustable



IP66 IK08

Technical specifications(Ta=25 °C) GWT 650 °C / 850 °C

Model	SL-SFA00-220LT-H-O	SL-SFA00-440LT-H-O	SL-SFA00-560LT-H-O
Length	60 cm (2 feet)	120cm (4 feet)	150cm (5 feet)
Power(adjustable)	12/14/17/20 W	25/30/35/40 W	35/40/50/60 W
Weight	0.77 KG	1.26 KG	1.55 KG
Cover	Diffusion/frost		
Material	ABS + PC / PC + PC / GRP + PC		
Energy Efficiency Class	A+		
Electrical Protection	Class I		
Color	3000K / 4000K / 5000K (adjustable)		
CRI	>80		
Luminous efficacy (lm/w)	120-130	120-130	120-130
Driver	Osram		
Input Voltage	200~240V AC 50/60Hz		
Power Factor	≥0.92		
THD	≤20%		
Beam angle	120°		
Average Lifespan Ta25 °C	>50,000 hours		
Warranty	5 years		
Operating Temperature	-20°C~+45°C		
IP Rating	IP66		
Standard	CE、RoHS、D-MARK、SAA、IK08		

- *Note: 1) 3000K comes up with lower lumen.
 2) Luminous Flux tolerance ±5%.
 3) The above data are tested by Fulton instruments.

*Please contact our sales representative to order products that don't have order codes listed here or any info required
 *Due to continuing product improvements, we reserves the right to change the specifications without notice.



re-light

IK08 **IP66**
IMPACT PROTECTION OUTDOOR RATED



IP66 IK08



0-10V dimmable & CCT Adjustable

Technical specifications(Ta=25 °C) GWT 650 °C / 850 °C

Model	SL-SFA00-220LT-H-O	SL-SFA00-440LT-H-O	SL-SFA00-560LT-H-O
Length	60 cm (2 feet)	120cm (4 feet)	150cm (5 feet)
Power	20 W	40 W	60 W
Weight	0.85 KG	1.35 KG	1.65 KG
Cover	Diffusion/frost		
Material	ABS + PC / PC + PC / GRP + PC		
Energy Efficiency Class	A+		
Electrical Protection	Class I		
Color	3000K / 4000K / 5000K (adjustable)		
CRI	>80		
Output Lumen	2400-2600 lm	4800-5200 lm	7200-7800 lm
Driver	BOKE		
Input Voltage	200~240V AC 50/60Hz		
Power Factor	≥0.92		
THD	≤20%		
Beam angle	120°		
Average Lifespan Ta25 °C	>50,000 hours		
Warranty	5 years		
Operating Temperature	-20°C~+45°C		
IP Rating	IP66		
Standard	CE、RoHS、D-MARK、SAA、IK08		

- *Note: 1) 3000K comes up with lower lumen.
 2) Luminous Flux tolerance ±5%.
 3) The above data are tested by SL instruments.

*Please contact our sales representative to order products that don't have order codes listed here or any info required

*Due to continuing product improvements, we reserves the right to change the specifications without notice.



re-light



IK08 **IP66**
IMPACT PROTECTION OUTDOOR RATED



DALI Dimmable & CCT Adjustable



IP66 IK08

Technical specifications(Ta=25 °C) GWT 650 °C / 850 °C

Model	SL-SFA00-220LT-H-O	SL-SFA00-440LT-H-O	SL-SFA00-560LT-H-O
Length	60 cm (2 feet)	120cm (4 feet)	150cm (5 feet)
Power	20 W	40 W	60 W
Weight	0.85 KG	1.35 KG	1.65 KG
Cover	Diffusion/frost		
Material	ABS + PC / PC + PC / GRP + PC		
Energy Efficiency Class	A+		
Electrical Protection	Class I		
Color	3000K / 4000K / 5000K (adjustable)		
CRI	>80		
Luminous efficacy (lm/w)	2400-2600 lm	4800-5200 lm	7200-7800 lm
Driver	Osram		
Input Voltage	200~240V AC 50/60Hz		
Power Factor	≥0.92		
THD	≤20%		
Beam angle	120°		
Average Lifespan Ta25 °C	>50,000 hours		
Warranty	5 years		
Operating Temperature	-20°C~+45°C		
IP Rating	IP66		
Standard	CE、RoHS、D-MARK、SAA、IK08		

- *Note: 1) 3000K comes up with lower lumen.
- 2) Luminous Flux tolerance ±5%.
- 3) The above data are tested by SL instruments.

*Please contact our sales representative to order products that don't have order codes listed here or any info required

*Due to continuing product improvements, we reserves the right to change the specifications without notice.



re-light

IK08 **IP66**
IMPACT PROTECTION OUTDOOR RATED



IP66 **IK08**

Emergency & CCT Adjustable

Technical specifications(Ta=25 °C) GWT 650 °C / 850 °C

Model	SL-SFA00-220LT-H-O	SL-SFA00-440LT-H-O	SL-SFA00-560LT-H-O
Length	60 cm (2 feet)	120cm (4 feet)	150cm (5 feet)
Power	20 W	40 W	60 W
Weight	0.95 KG	1.45 KG	1.75 KG
Cover	Diffusion/frost		
Material	ABS + PC / PC + PC / GRP + PC		
Energy Efficiency Class	A+		
Electrical Protection	Class I		
Color	3000K / 4000K / 5000K (adjustable)		
CRI	>80		
Luminous efficacy (lm/w)	2400-2600	4800-5200	7200-7800
Driver	Tridonic + Yihui		
Emergency time and Power	3hours/2w		
Input Voltage	200~240V AC 50/60Hz		
Power Factor	≥0.92		
THD	≤20%		
Beam angle	120°		
Average Lifespan Ta25 °C	>50,000 hours		
Warranty	5 years		
Operating Temperature	-20°C~+45°C		
IP Rating	IP66		
Standard	CE、RoHS、D-MARK、SAA、IK08		

*Note: 1) 3000K comes up with lower lumen. 2) Luminous Flux tolerance ±5%. 3) The above data are tested by SL instruments.

*Please contact our sales representative to order products that don't have order codes listed here or any info required

*Due to continuing product improvements, we reserves the right to change the specifications without notice.



re-light

IK08 **IP66**
IMPACT PROTECTION OUTDOOR RATED



Microwave Induction & CCT Adjustable



IP66

IK08

Technical specifications(Ta=25 °C) GWT 650 °C / 850 °C

Model	SL-SFA00-220LT-H-O	SL-SFA00-440LT-H-O	SL-SFA00-560LT-H-O
Length	60 cm (2 feet)	120cm (4 feet)	150cm (5 feet)
Power	20 W	40 W	60 W
Weight	0.77 KG	1.26 KG	1.55 KG
Cover	Diffusion/frost		
Material	ABS + PC / PC + PC / GRP + PC		
Energy Efficiency Class	A+		
Electrical Protection	Class I		
Color	3000K / 4000K / 5000K / 6000K		
CRI	>80		
Rated luminous Flux(lm)	2200-2400	4800-5200	7200-7800
Input Voltage	200~240V AC 50/60Hz		
Detection sensor	HAISEN		
Microwave frequency	5.8GHz±75MHz		
Detection sensitivity(area)	50%/100%		
Hold time	5s/60s/3min/10min		
Daylight threshold	30lux/Disable		
Mounting height	6-15m		
Detection angle	30° - 150°		
Motion detection	0.5 ~ 3 m/s		
Power Factor	≥0.92		
THD	≤20%		
Beam angle	120°		
Warranty	5 years		
Operating Temperature	-20°C~+45°C		
IP Rating	IP66		
Standard	CE、RoHS、D-MARK、WEEE、IK10		



Microwave Induction & CCT Adjustable

ON/OFF function

We preset the product in customize, 100%---> low light or off. Easy to install and cost-effective.

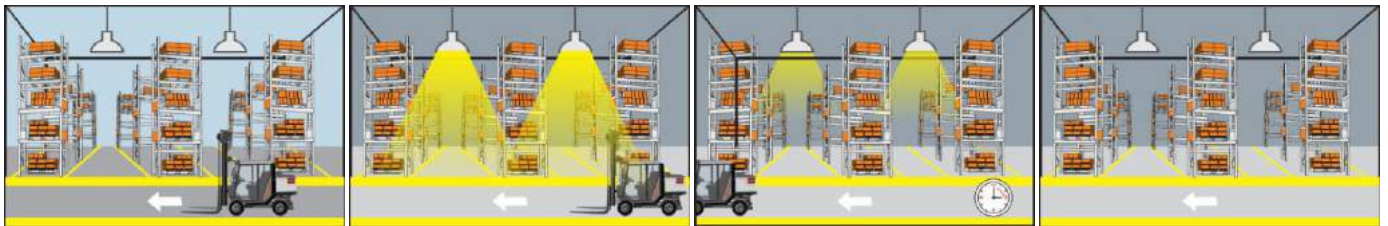

Detection Pattern

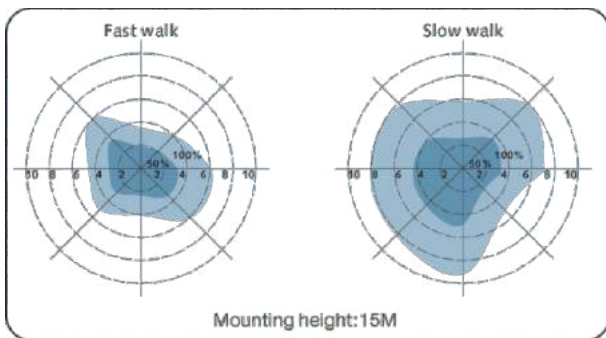
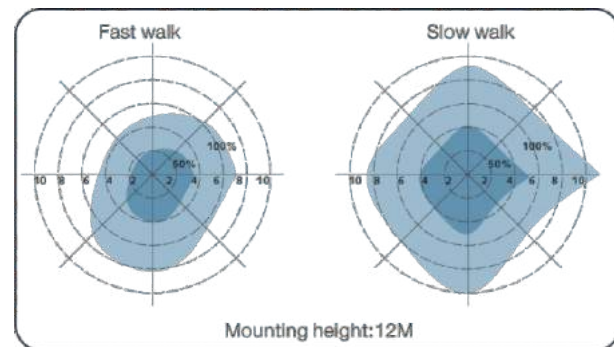
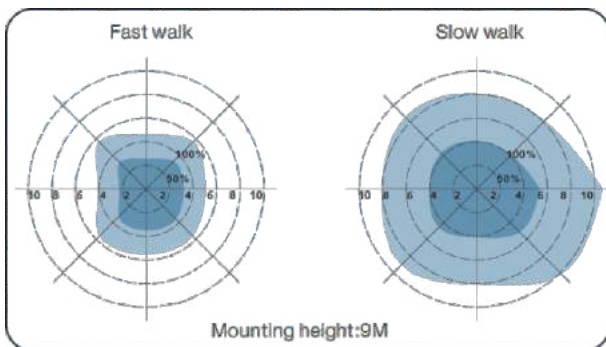
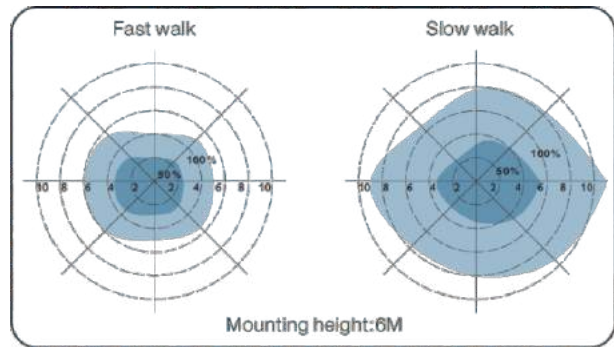
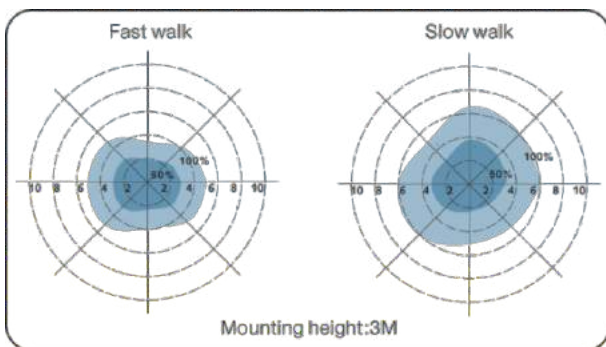

LED Tri-proof light



re-light

Operation of changing power and changing CCT

Item	Current corresponding to different power			
	350 mA	300 mA	250 mA	200 mA
0.6m	20 W	17 W	14 W	12 W
1.2m	40 W	35 W	30 W	25 W
1.5m	60 W	50 W	40 W	35 W

	PIN 1	PIN 2	CURRENT
	ON	ON	350 mA
	ON	OFF	300 mA
	OFF	ON	250 mA
	OFF	OFF	200 mA

	Item	CCT		
	0.6m	3000 K	4000 K	5000 K
	1.2m	3000 K	4000 K	5000 K
	1.5m	3000 K	4000 K	5000 K



LED Tri-proof light



re-light

Photometric Diagram

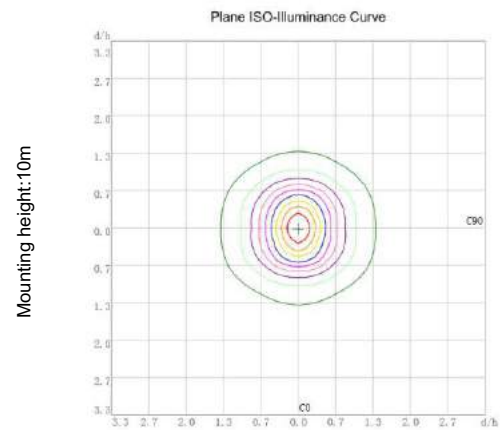
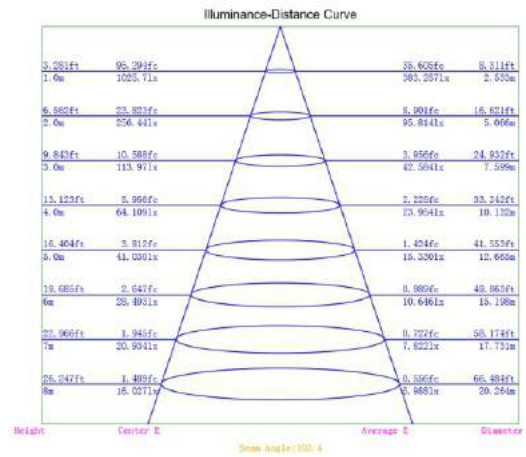
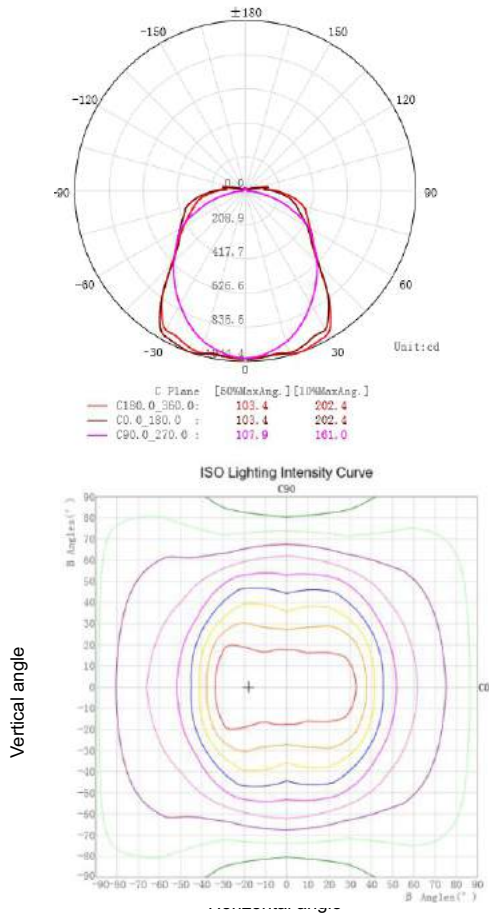

Lifetime + Sustainability

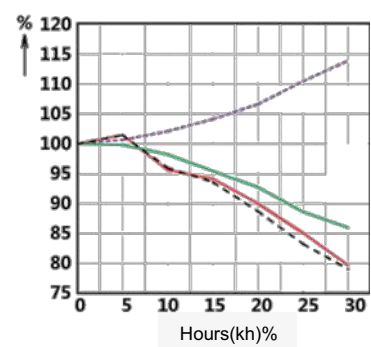
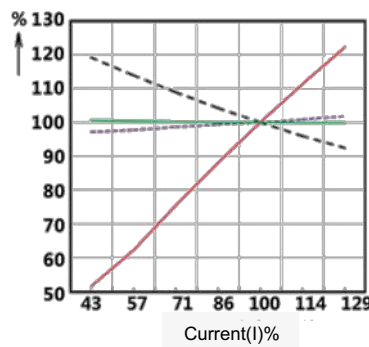
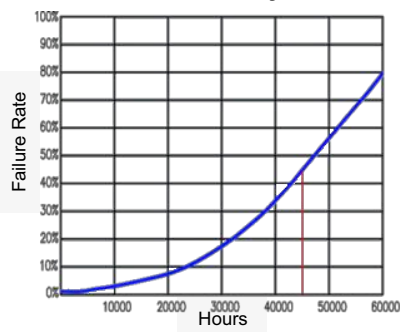

— Luminous Efficacy - - Rated Luminous Flux - - - CCT - - CRI

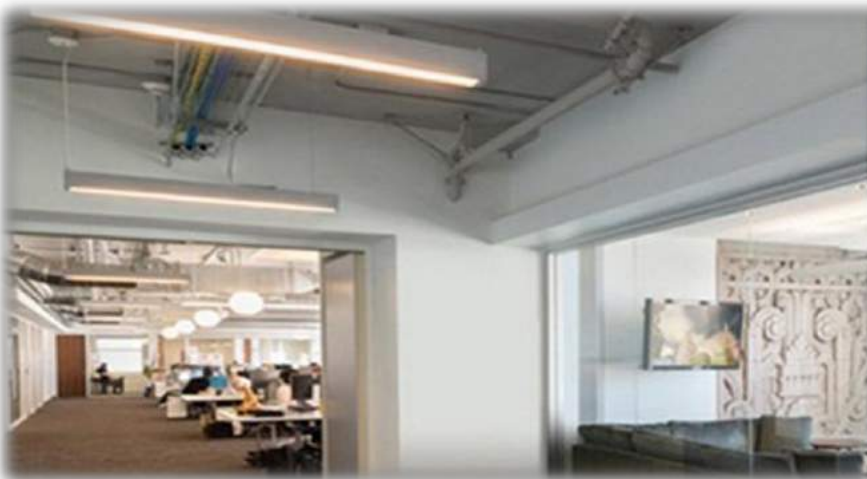

LED Tri-proof light



re-light

Wiring diagram

Cautions:

Before installation, be sure to cut off electricity to avoid electric shock.

This is one end wiring LED Tri-proof light with build-in driver. Powered by the voltage labeled on the LED Tri-proof light, no need to add other drivers.

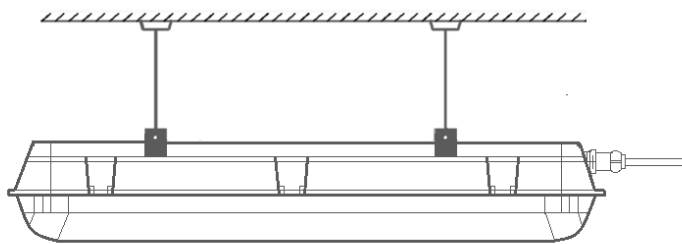

hanging

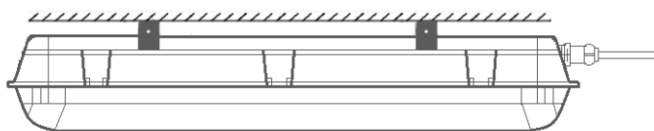

Ceiling type

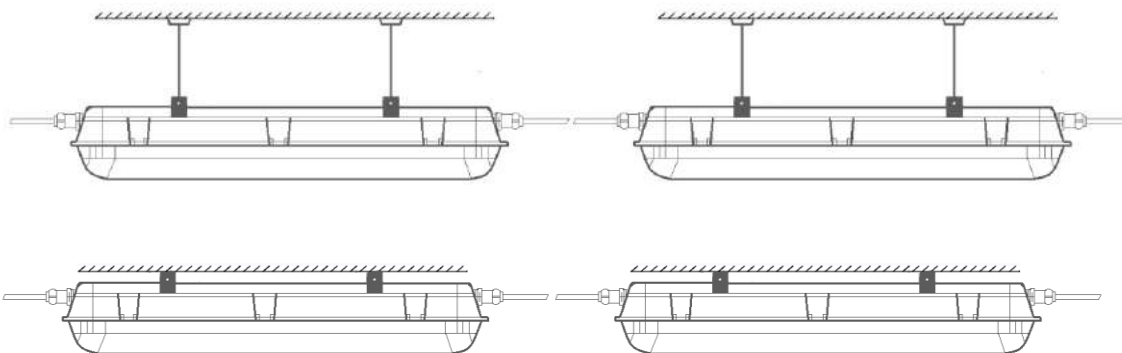

LED Tri-proof light



re-light

Package Information

Item	Length	O'ty per carton (pcs)	G.W (KG)	Carton size L*W*H (mm)
FLT-TP-L6	0.6m	20	22	640*445*460
FLT-TP-L12	1.2m	10	18.5	1240*445*225
FLT-TP-L15	1.5m	10	24	1540*445*225

